

VIBIA

Assembly instructions / Instrucciones de montaje / Montageanleitung
Istruzioni di montaggio / Instructions de montage

Origami

Design by Ramon Esteve



Caution

Before assembling and installing this product, carefully read the following:

- Switch of the mains before installing the lamp.
- To install on the wall, always choose the most adequate fixing tools for the wall material.
- We recommend reading the manual before installing the lamp. Keep this instructions for future reference.
- Do not disassemble, modify or try to repair this fitting. In order to get technical assistance contact VIBIA. Any change or modification to the light fitting can null the manufacturer's guarantee.
- All electronic products and batteries must be taken to separate waste collection points at the end of their working lives, they must not be disposed of in normal household waste. It is the responsibility of the user to dispose of the equipment using a designated collection point or service for separate recycling of waste electrical and electronic equipment (WEEE) and batteries according to local laws.

Precaución

Antes de proceder al montaje e instalación de esta luminaria, leer detenidamente las siguientes consideraciones:

- Desconectar el suministro eléctrico antes de proceder a la instalación de la luminaria.
- Para el montaje de la luminaria a la pared elegir los elementos de fijación más adecuados en función del soporte de instalación.
- Recomendamos leer el manual antes de iniciar la instalación de la luminaria. Guardar estas instrucciones para futuras consultas.
- No desmonte, modifique, ni intente reparar la luminaria. Para recibir asistencia técnica, pongase en contacto con VIBIA. Cualquier cambio o modificación en la luminaria puede anular la garantía del fabricante.
- Todos los productos electrónicos y las baterías deben llevarse a puntos de recolección de residuos separados cuando finalicen sus ciclos de vida, no se deben desechar en la cadena normal de residuos con la basura doméstica. Es responsabilidad del usuario desechar los dispositivos en un punto o servicio de recolección designado para el reciclaje separado de residuos de aparatos eléctricos y electrónicos (WEEE), así como las baterías, de conformidad con las leyes locales.

Vorsicht

Bevor Sie mit der Montage dieser Leuchte beginnen, sollten Sie die folgenden Hinweise in aller Ruhe lesen und berücksichtigen:

- Schalten Sie vor dem elektrischen Anschluss den Strom ab.
- Wählen Sie passend zu der Vorrichtung für die Wandhalterung der Leuchte das dafür geeignetste Befestigungsmaterial.
- Wir empfehlen vor Montagebeginn die Anleitung zu lesen. Bewahren Sie die Anleitung für etwaige zukünftige Fragen auf.
- Die Leuchte nicht auseinanderbauen, baulich ändern oder reparieren. Für technische Hilfe VIBIA kontaktieren.
- Alle elektronischen Produkte und Batterien am Ende Ihrer Lebensdauer getrennt entsorgt werden müssen, sie dürfen nicht über den normalen Fluss des Haushaltsmülls entsorgt werden. Es unterliegt der Verantwortlichkeit des Benutzers, die Ausrüstung unter Verwendung einer ausgewiesenen Sammelstelle oder eines Dienstes für getrenntes Recycling von elektrischen oder elektronischen Geräten und Batterien entsprechend der Gesetze vor Ort zu entsorgen (WEEE = Waste of Electrical and Electronic Equipment = Elektro - und Elektronikgeräte - Abfall).

Attention

Prima di procedere al montaggio e all'installazione di questo apparecchio, leggere attentamente le seguenti considerazioni:

- Scollegare l'alimentazione prima di procedere all'installazione dell'apparecchio.
- Per il montaggio a parete, usare gli strumenti di fissaggio più adeguati in base al tipo di materiale della parete.
- Si consiglia di leggere il manuale prima di iniziare l'installazione dell'apparecchio. Salva queste istruzioni per future consultazioni.
- Non smontare, modificare né cercare di riparare la lampada. Per richiedere assistenza tecnica, mettersi in contatto con VIBIA. Qualsiasi cambiamento o modifica alla lampada può annullare la garanzia del fabbricante.
- Tutti i prodotti elettronici e le batterie devono essere separate in punti di raccolta dei rifiuti una volta terminato l'utilizzo, non devono essere smaltiti nel normale flusso dei rifiuti insieme ai rifiuti domestici. È responsabilità dell'utente smaltire l'apparecchiatura utilizzando un punto di raccolta o un servizio per il riciclo di rifiuti di apparecchiature elettriche ed elettroniche (RAEE) e batterie secondo le leggi vigenti.

Attenzione

Avant de procéder à l'assemblage et à l'installation de ce luminaire, lisez attentivement les considérations suivantes:

- Débranchez l'alimentation avant de procéder à l'installation du luminaire.
- Pour fixer le luminaire au mur, utilisez les éléments de fixation les mieux adaptés au support.
- Nous vous recommandons de lire le manuel avant de commencer l'installation du luminaire. Sauvegardez ces instructions pour futures consultations.
- Ne démontez pas le luminaire, ne le modifiez pas et n'essayez pas de le réparer. Pour bénéficier d'une assistance technique, contactez VIBIA. Toute altération ou modification du luminaire peut annuler la garantie du fabricant.
- Tous les produits électroniques et toutes les batteries doivent être apportés à des points de collecte distincts de ceux des ordures ménagères normales lorsqu'ils arrivent en fin de vie. Il incombe à l'utilisateur de se débarrasser de l'équipement dans un point de collecte ou auprès d'un service spécifiquement désigné pour le recyclage des déchets électriques et des équipements électroniques (DEEE) ainsi que des batteries, dans le respect de la législation locale.





Step 1
Product Spec Sheet



Step 2
Supplied Materials















Step 3
Installation Preparation



Step 1/3

Product Spec Sheet

Technical specifications / Especificaciones técnicas / Technische Daten
Specifiche tecniche / Caractéristiques techniques

| | | | | | | | | |
|-----------------------------------------------------|----------|-----------------------------------------------------------------------------------|--------------------------|-------------------------------------------------------------------------------------|-------------------------------------------------------------------------------------|-------------------------------------------------------------------------------------|------------|--|
| 4504 | | | | | | | | |
| Net Weight / Peso Neto / Netto-Gewicht / Peso netto | 2,15 Kg. |  | 2 x LED STRIP 6,3W 350mA |  |  |  | ~ 50/60 Hz | |
| Poids net | | | | | | | | |
| 4506 | | | | | | | | |
| Net Weight / Peso Neto / Netto-Gewicht / Peso netto | 3,23 Kg. |  | 3 x LED STRIP 6,3W 350mA |  |  |  | ~ 50/60 Hz | |
| Poids net | | | | | | | | |
| 4508 | | | | | | | | |
| Net Weight / Peso Neto / Netto-Gewicht / Peso netto | 4,30 Kg. |  | 4 x LED STRIP 6,3W 350mA |  |  |  | ~ 50/60 Hz | |
| Poids net | | | | | | | | |



Class I. Product with an additional protection cable (grounds).

Clase I. Aparato con un cable protector adicional (toma de tierra).

Klasse I. Apparat mit zusätzlichen Schutzleiter (Erdkabel).

Classe I. Apparecchio con un cavo di protezione aggiuntivo (presa di terra).

Classe I. Appareil avec câble d'isolation additionnel (borne de terre).

IP65

Dust-tight product. Protected against water trickles.

Producto totalmente estanco al polvo. Protegido contra los chorros de agua.

Staubdicht. Schutz gegen das Eindringen von Strahlwasser.

Prodotto antipolvere. Protetto contro i rivoli d'acqua.

Totalement protégé contre les poussières. Protégé contre les jets d'eau de toutes directions à la lance.



Alternating current.

Corriente alterna.

Wechselstrom.

Corrente alternata

Courant alternatif.



Step 2/3

Supplied Materials

Supplied material / Material suministrado / Geliefertes Material
Materiale incluso / Matériel fourni

| | 4504 | 4506 | 4508 |
|------------------------------------------------------------------------------------------------------------|-------|-------|-------|
| 1. Template / Plantilla / Schablone / Modello / Modèle | 2 un. | 2 un. | 2 un. |
| 2. Components bag / Bolsa componentes / Tütchen mit Teilen / Sacchetto componenti / Sachet d'accessoires | 1 un. | 1 un. | 1 un. |
| 3. Frontal 4500 / Frontal 4500 / Frontal 4500 / Frontal 4500 / Frontal 4500 | 2 un. | 2 un. | 3 un. |
| 4. Frontal 4501 / Frontal 4501 / Frontal 4501 / Frontal 4501 / Frontal 4501 | - | 1 un. | 1 un. |
| 5. Lighting fixture / Estructura luminaria / Leuchtenstruktur / Struttura lampada / Structure du luminaire | 1 un. | 1 un. | 1 un. |

1

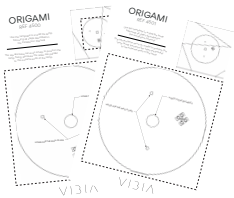

2



3

Frontal 4500

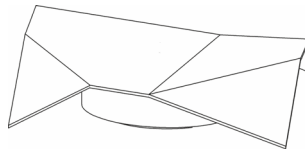

4

Frontal 4501

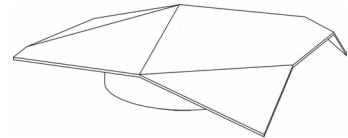

5

Ref. 4504



Ref. 4506

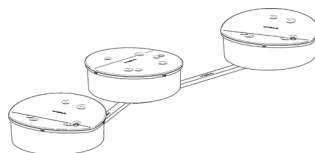

Ref. 4508

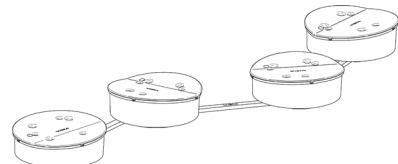



Step 3/3 Installation Preparation

3.1

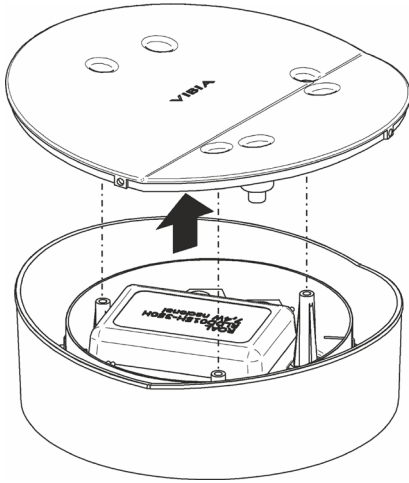

3.2

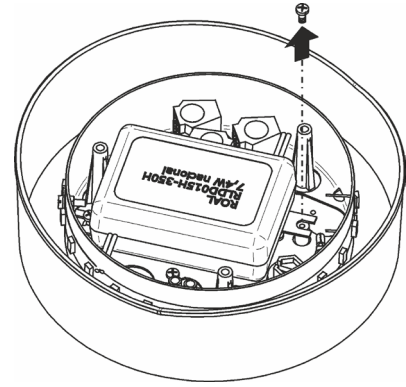

3.3

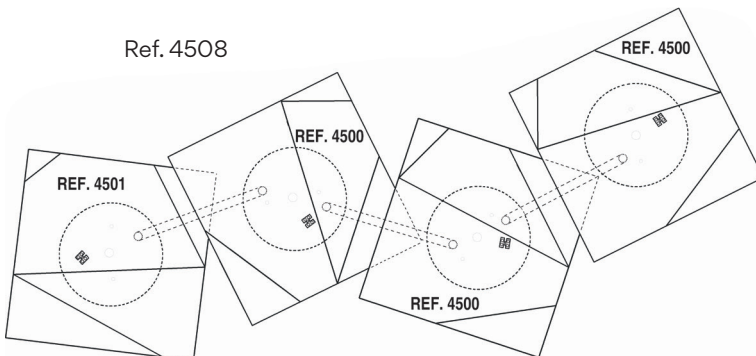
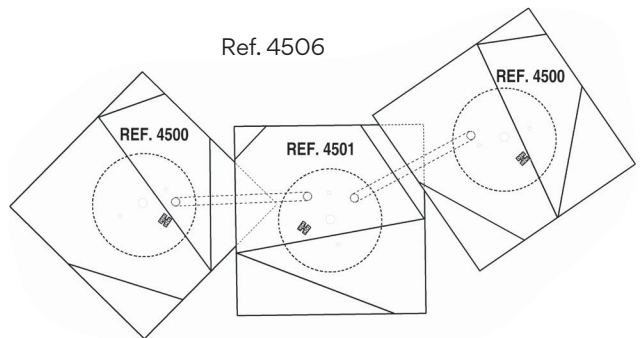
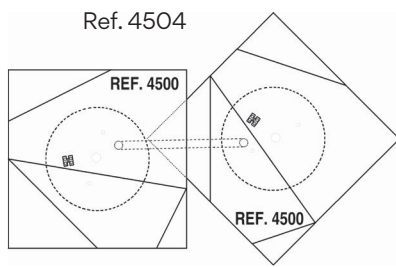



Step 3/3 Installation Preparation

3.4

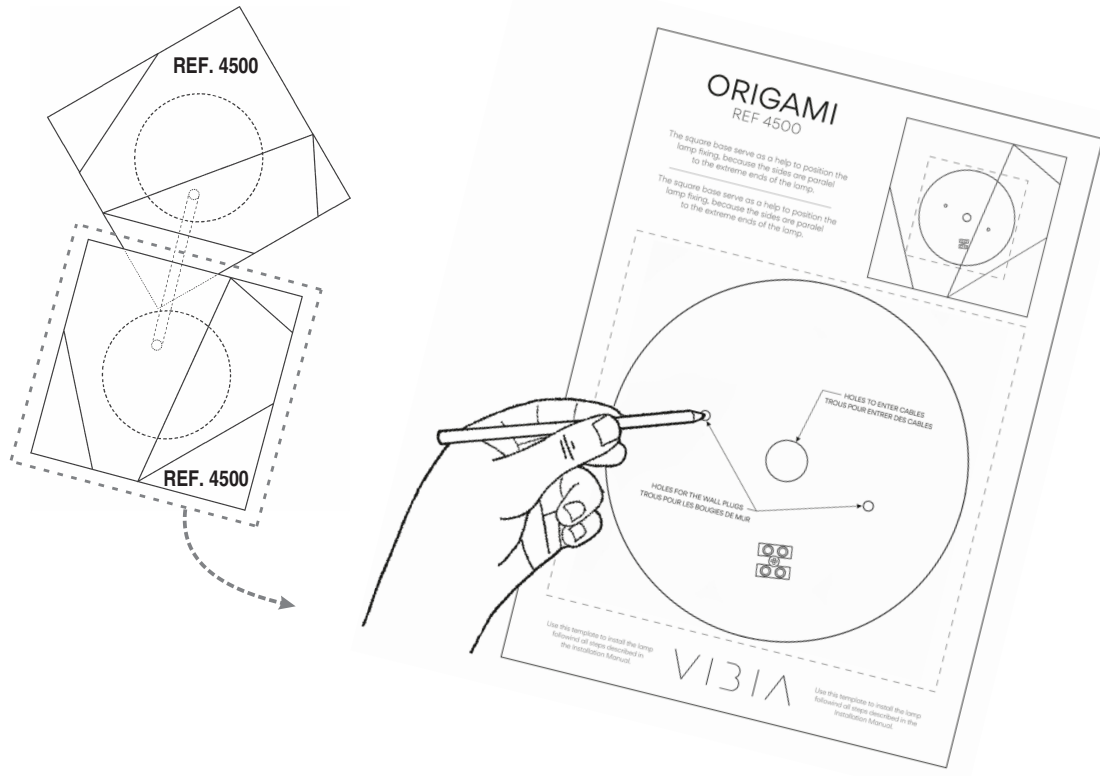

3.5

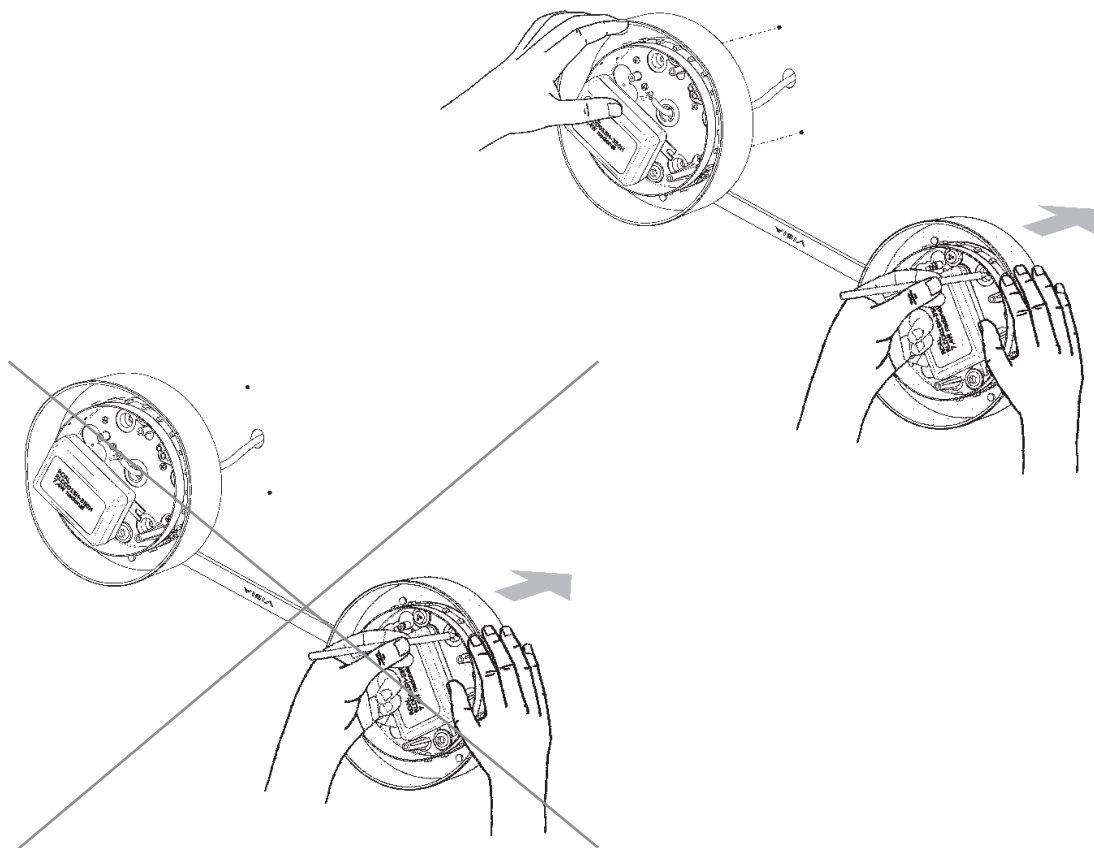



Step 3/3
Installation Preparation

3.6

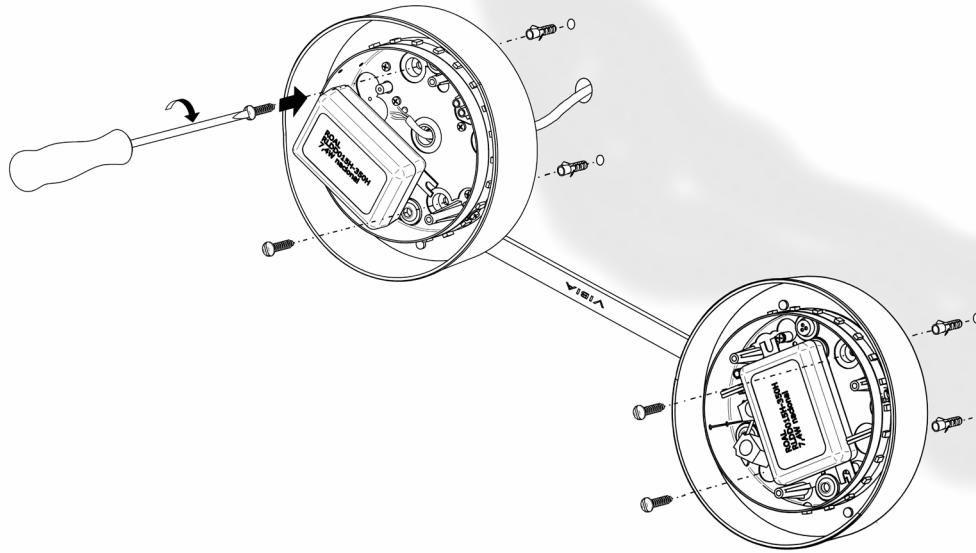

3.7

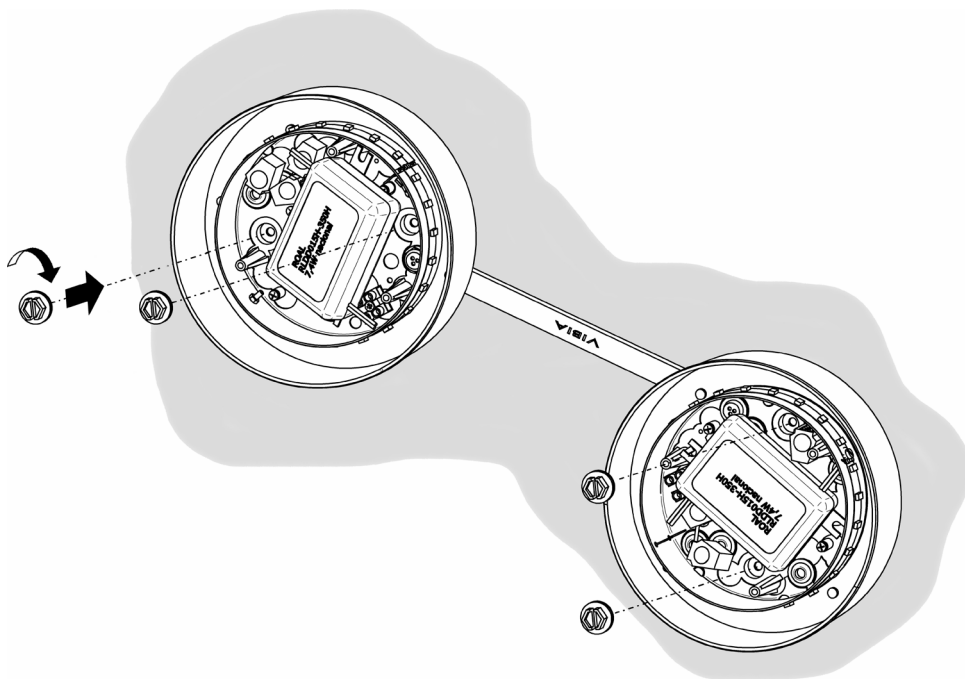



Step 3/3 Installation Preparation

3.8

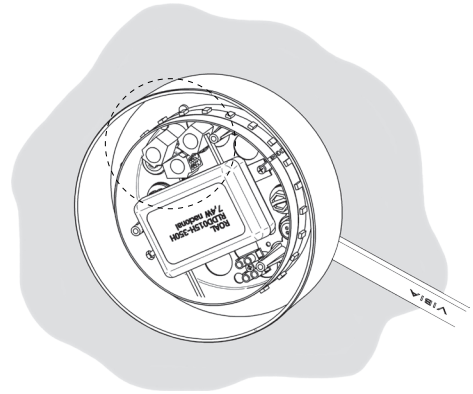
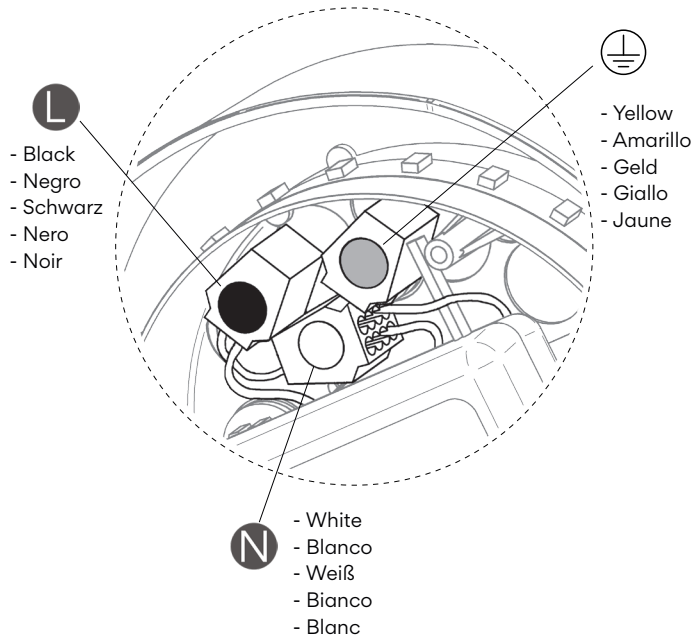

3.9

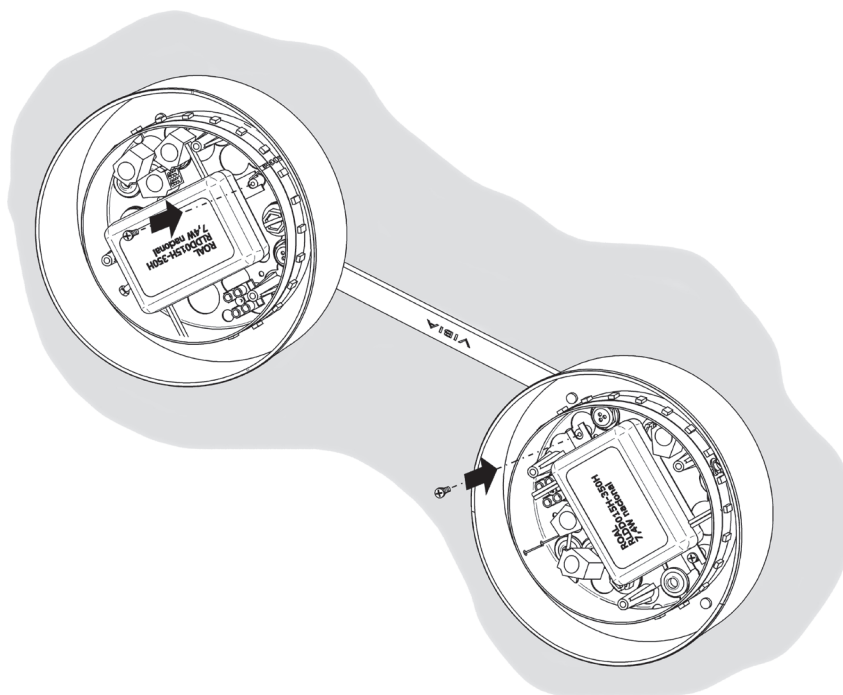



Step 3/3 Installation Preparation

3.10

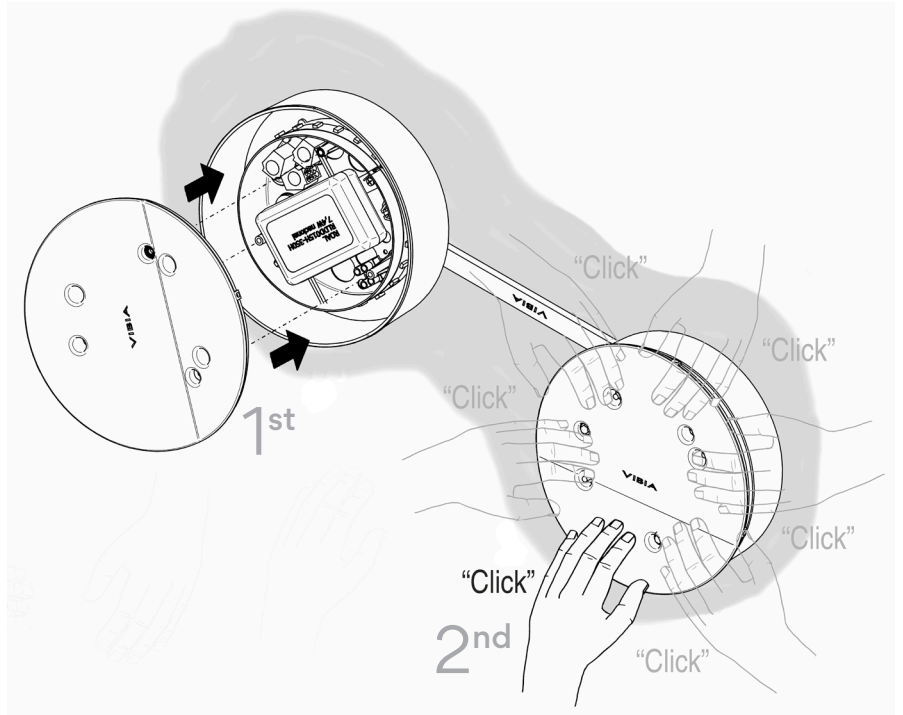
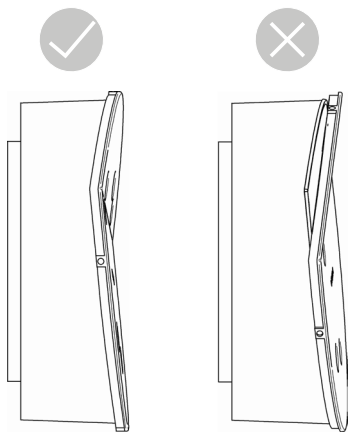

3.11

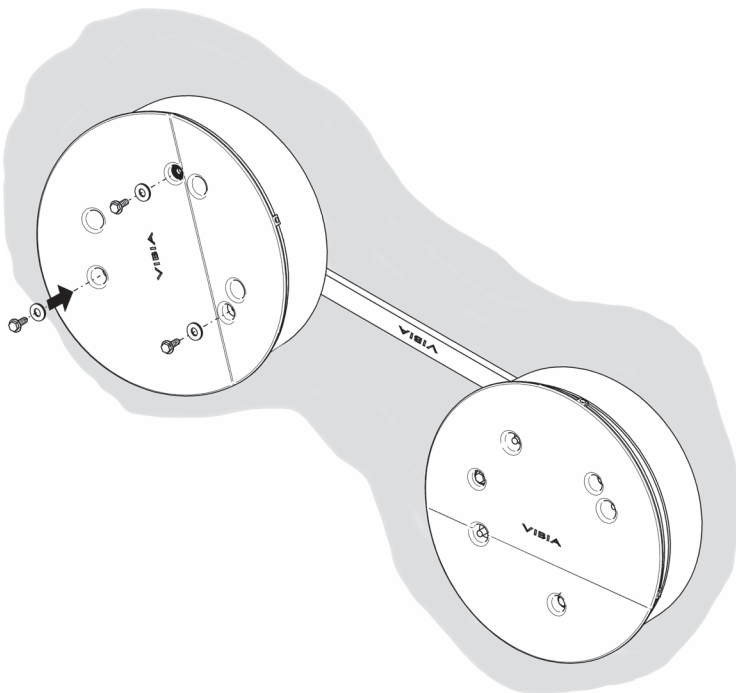



Step 3/3 Installation Preparation

3.12

Ref. 4504

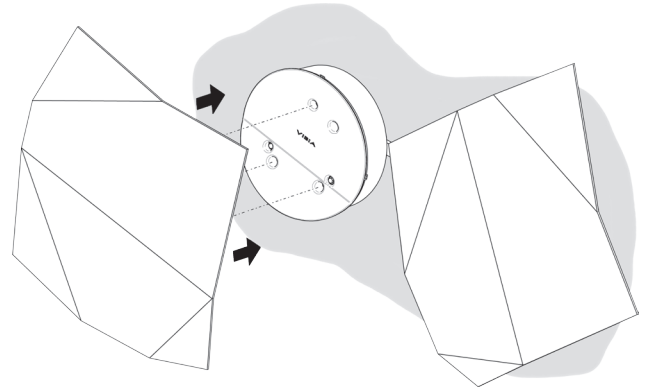
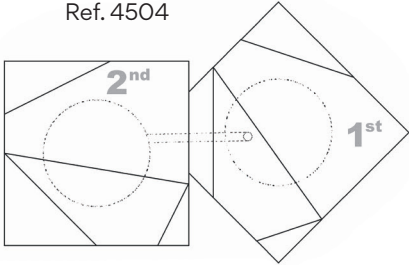

Ref. 4506

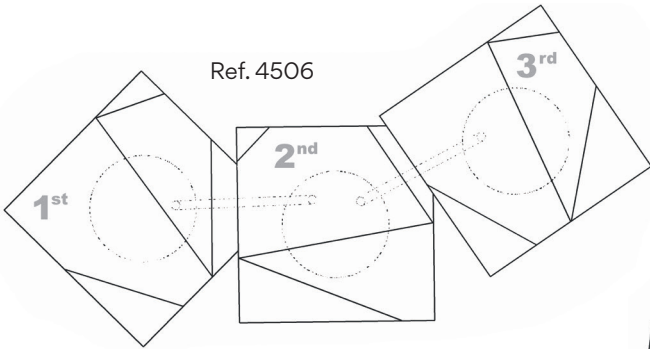

Ref. 4508

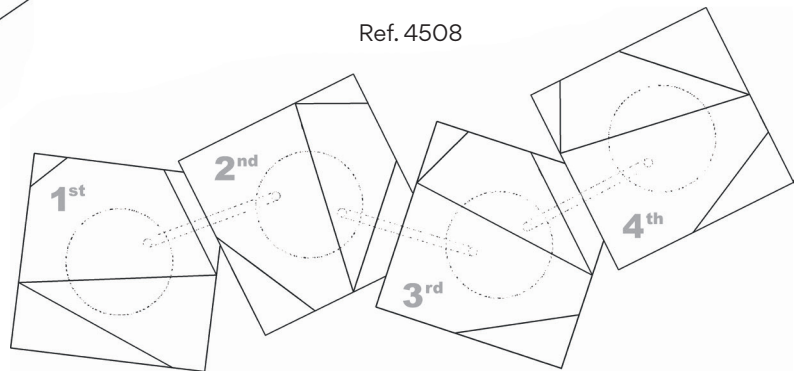

3.13

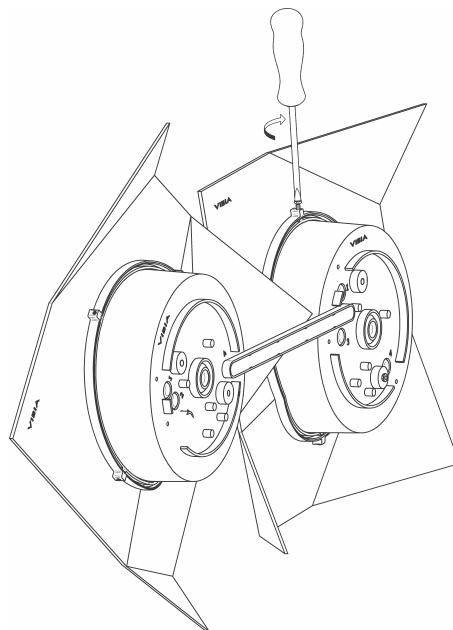

Maintenance

Use a slightly-wet cotton cloth for cleaning.

In case of malfunction or damage, please contact the retailer who sold the lamp.

Mantenimiento

Para limpiar la luminaria, usar un paño de algodón ligeramente humedecido en agua.

En caso de avería o incidente con la luminaria, contactar directamente con el establecimiento en que se adquirió.

Instandhaltung

Zur Reinigung der Leuchte nutzen Sie einen leicht angefeuchteten Baumwoll-Lappen.

Im Falle des Ausfalls oder einer Fehlfunktion der Leuchte setzen Sie sich direkt mit dem Unternehmen in Verbindung bei dem Sie die Leuchte bezogen haben.

Manutenzione

Per la pulizia della lampada, usare un panno di cotone leggermente inumidito con acqua.

In caso di guasto o incidente con la lampada, rivolgersi direttamente al rivenditore da cui è stata acquistata.

Entretien

Pour nettoyer le luminaire, utilisez un chiffon en coton légèrement humidifié d'eau.

En cas d'incident ou de défaillance du luminaire, contactez directement l'établissement où vous l'avez acheté.

Vibia Lighting, S.L.U.

Spain & Portugal T. +34 934 796 970

International T. +34 934 796 971

customer.service@vibia.com

www.vibia.com

VIBIA

ORIGAMI

REF 4500

Use this template to install the lamp following all steps described in the Installation Manual.

The square base serve as a help to position the lamp fixing, because the sides are parallel to the extreme ends of the lamp.

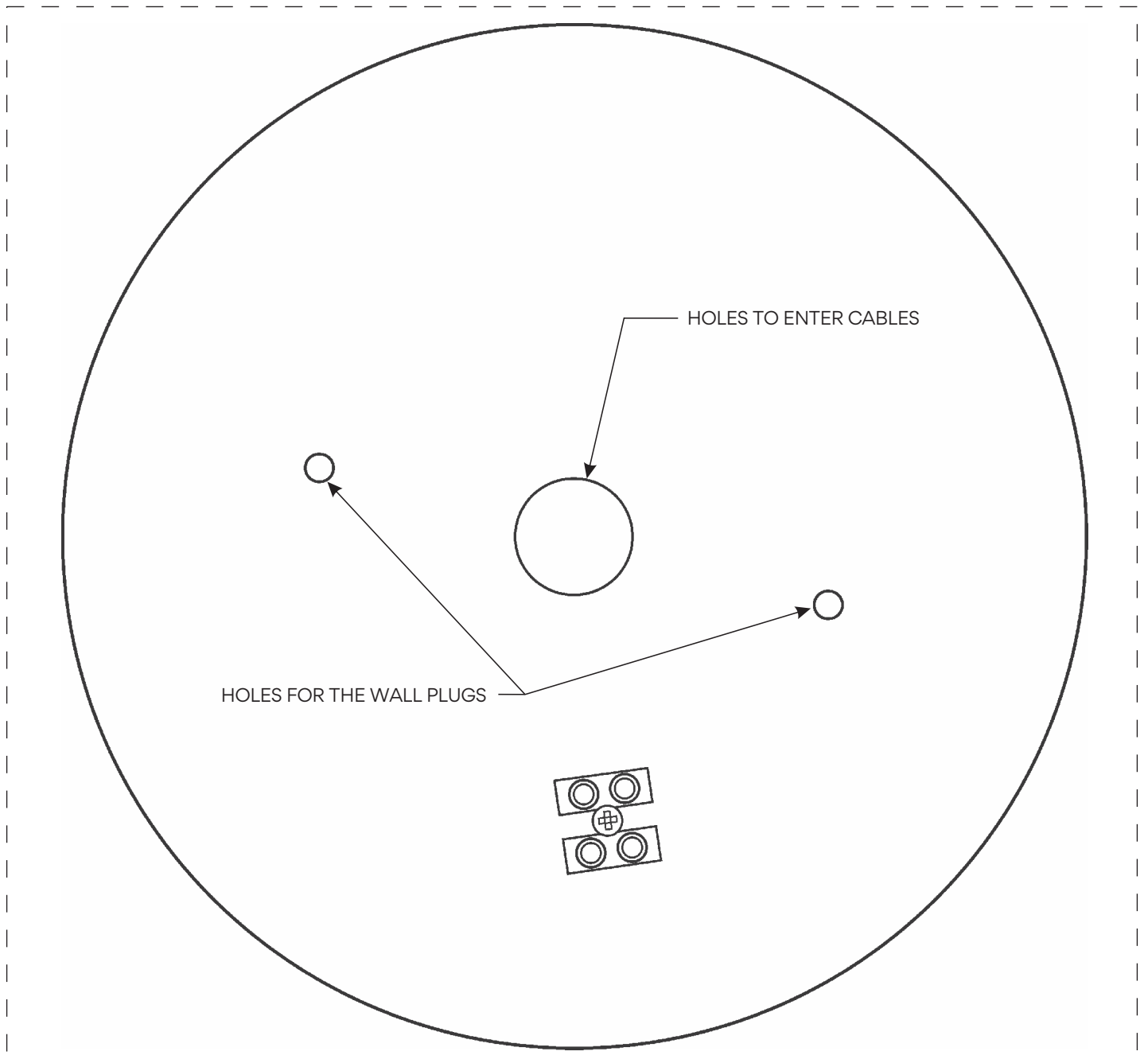
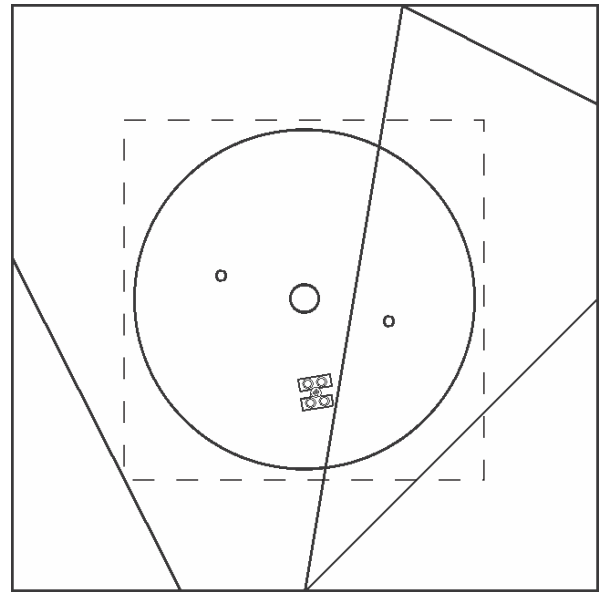

VIBIA

ORIGAMI

REF 4501

Use this template to install the lamp following all steps described in the Installation Manual.

The square base serve as a help to position the lamp fixing, because the sides are parallel to the extreme ends of the lamp.

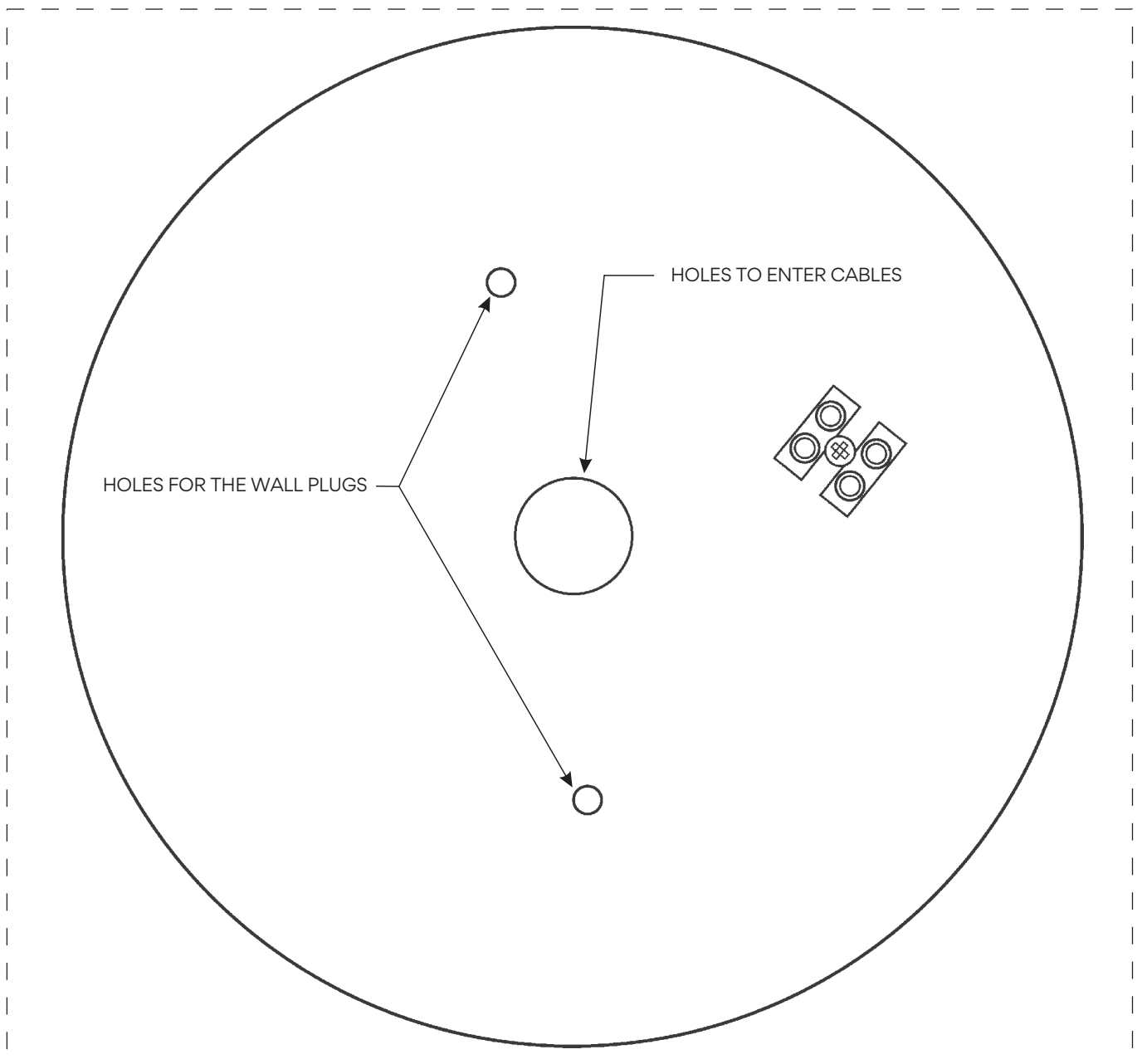
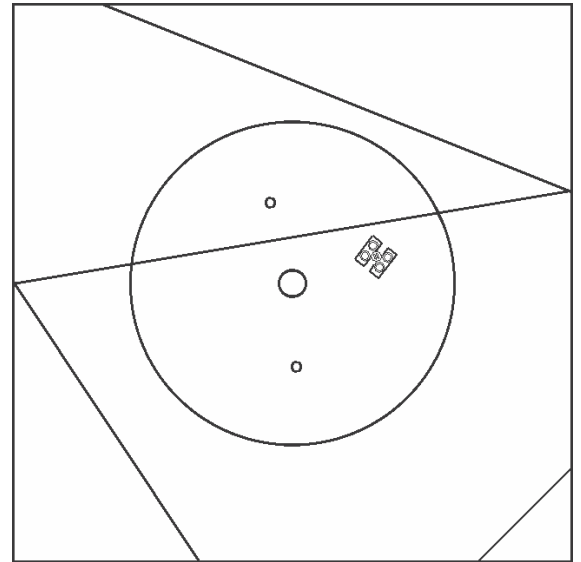

VIBIA

VIBIA

WARNING

To avoid any possible damage to the union arms, handle the light fitting through the extremes.
Do not take for just one plate.

ADVERTENCIA

Para evitar posibles daños a los brazos de unión, manejar la luminaria por los extremos.
No manejar de un solo plato.

WARNUNG

Um Schäden an den Verbindungen zu vermeiden, ist die Leuchte an den Enden anzufassen.
Nicht an nur einer Scheibe anheben.

AVVERTIMENTO

Per evitare ogni possibile danno alle braccia di unione, maneggiare il luminare attraverso gli estremi.
Non prendere un solo piatto.

AVERTISSEMENT

Pour éviter tout dommage possible aux bras de l'union, manipulez le luminaire à travers les extrêmes.
Ne pas prendre juste une seule plaque.

